

Professional warewashing technology

M-iQ Flight and rack type dishwashing machine



M-iQ

The future of dishwashing



M-iQ – Holistic cleaning technology
for people and the environment



You do not need more water and energy to clean hygienically; you need more thought – this is MEIKO's philosophy. We are continually developing cleaning technologies but are striving not only to advance technology; we have the bigger picture in mind – people, nature and resources. We unequivocally demand sustainable cleaning technology for a clean world. We strive to integrate apparently contradictory demands into a coherent concept. Absolute hygiene and safety on the one hand, frugal use of water and energy on the other. Awareness of costs as well as economical technology and the use of the most modern intelligent technologies. A Herculean task. MEIKO has taken on this challenge, covering all essential aspects of cleaning technology.

The result: M-iQ. A new definition of cleaning technology.



M-iQ Highlights

The
dis
bal
anc
in c
thru
exh
a c
ope

Touch glass control panel.

M-iQ Energy Concept

three-stage heat output

dynamic adjustment

optimum energy efficiency



M-iQ GreenEye-Technology®

- > teamwork between people and machines
- > hassle-free dishwashing process
- > optimized capacity utilization enables significant savings

M-iQ AirConcept

maximum energy efficiency

full compliance with DIN standards

no need for exhaust air connection



M-iQ Filter

revolutionary filter system

active dirt removal

maximum process efficiency

M-iQ Feeding section cleaning

Clean right from the start

Hygienic cleaning for MEIKO starts at the infeed section. Food particles are continuously flushed away with a

powerful wave action. Like an enormous cleansing torrent.

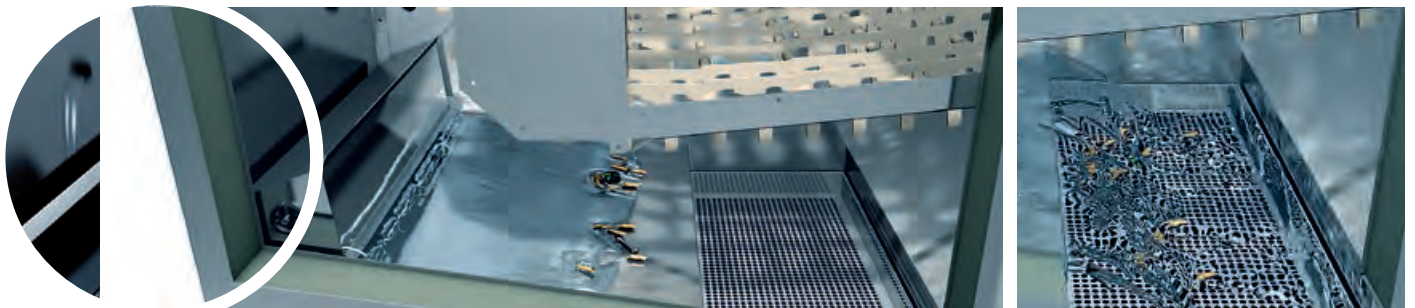
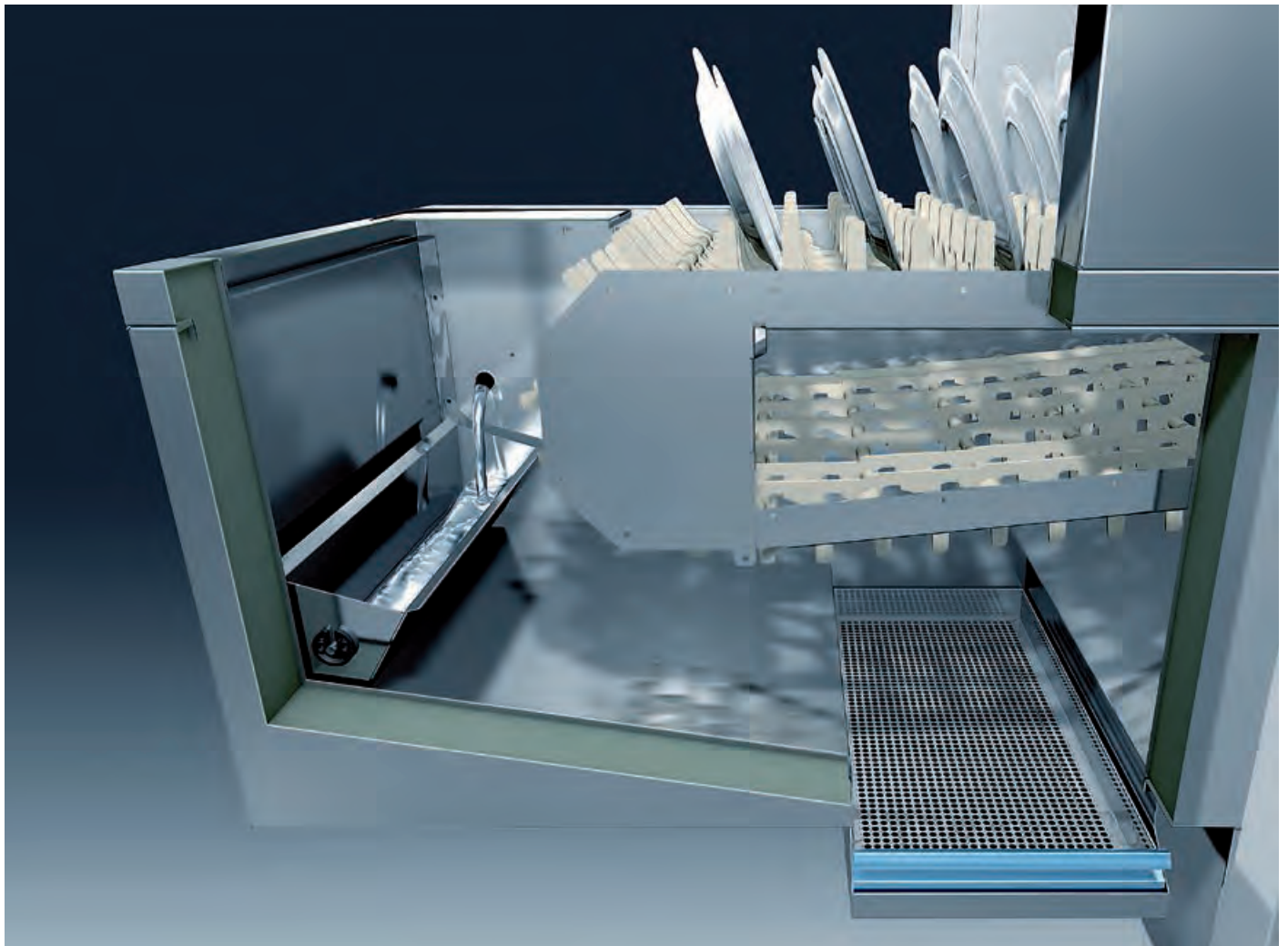

Wash water is collected and flushes the food particles into the collection filter using a powerful wave action.

M-iQ Filter

In harmony with the environment



The highlight and core feature of the M-iQ is the *M-iQ Filter*. This filter system pulls off an amazing feat by achieving optimum cleanliness with significantly reduced water and detergent consumption. It does this by actively removing filtered food waste from the dishwashing process.

The filter collects the food residue from the water and then periodically washes it out of the tank – all without requiring any additional water. That's the unique M-iQ recipe for outstanding cleanliness.

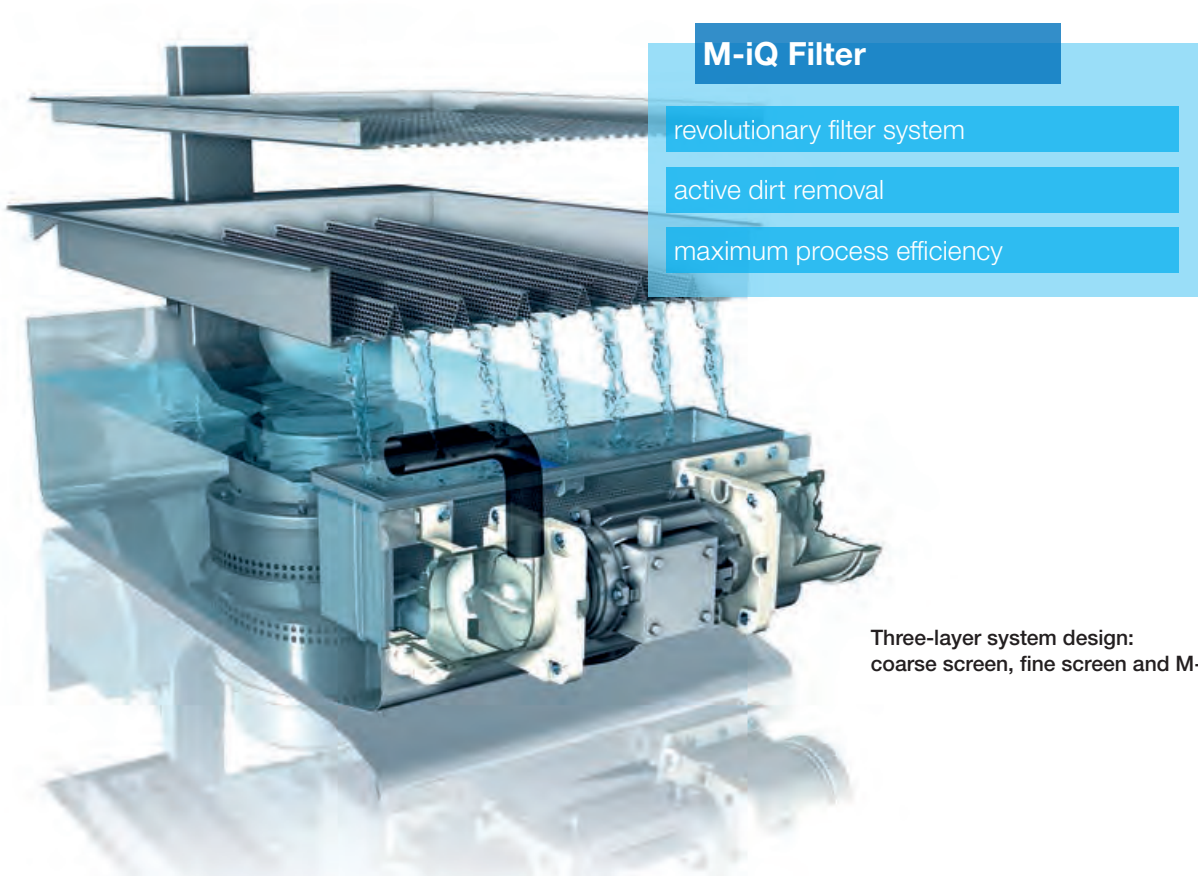

M-iQ Filter

revolutionary filter system

active dirt removal

maximum process efficiency

Three-layer system design:
coarse screen, fine screen and M-iQ filter unit



During the wash process the food waste is continuously filtered out by a coarse filter and a self-cleaning fine filter.



Periodical backwashes remove the collected food waste from the tank – a revolutionary MEIKO innovation.

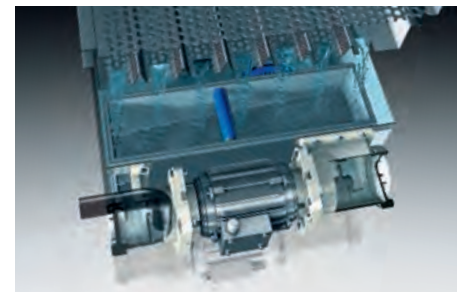

That eliminates the food waste from the dishwashing process and makes the wash water cleaner and more effective – without requiring any additional water.

M-iQ Energy Concept

Energy like never before

All the processes in the M-iQ are designed to recover heat and channel it back into the system through an innovative process of energy management and control. Thanks to its special, dynamically adaptable design, the M-iQ makes

carefully metered use of valuable energy. That means lower energy costs as well as all-round improvements to the indoor climate in the wash-up area.

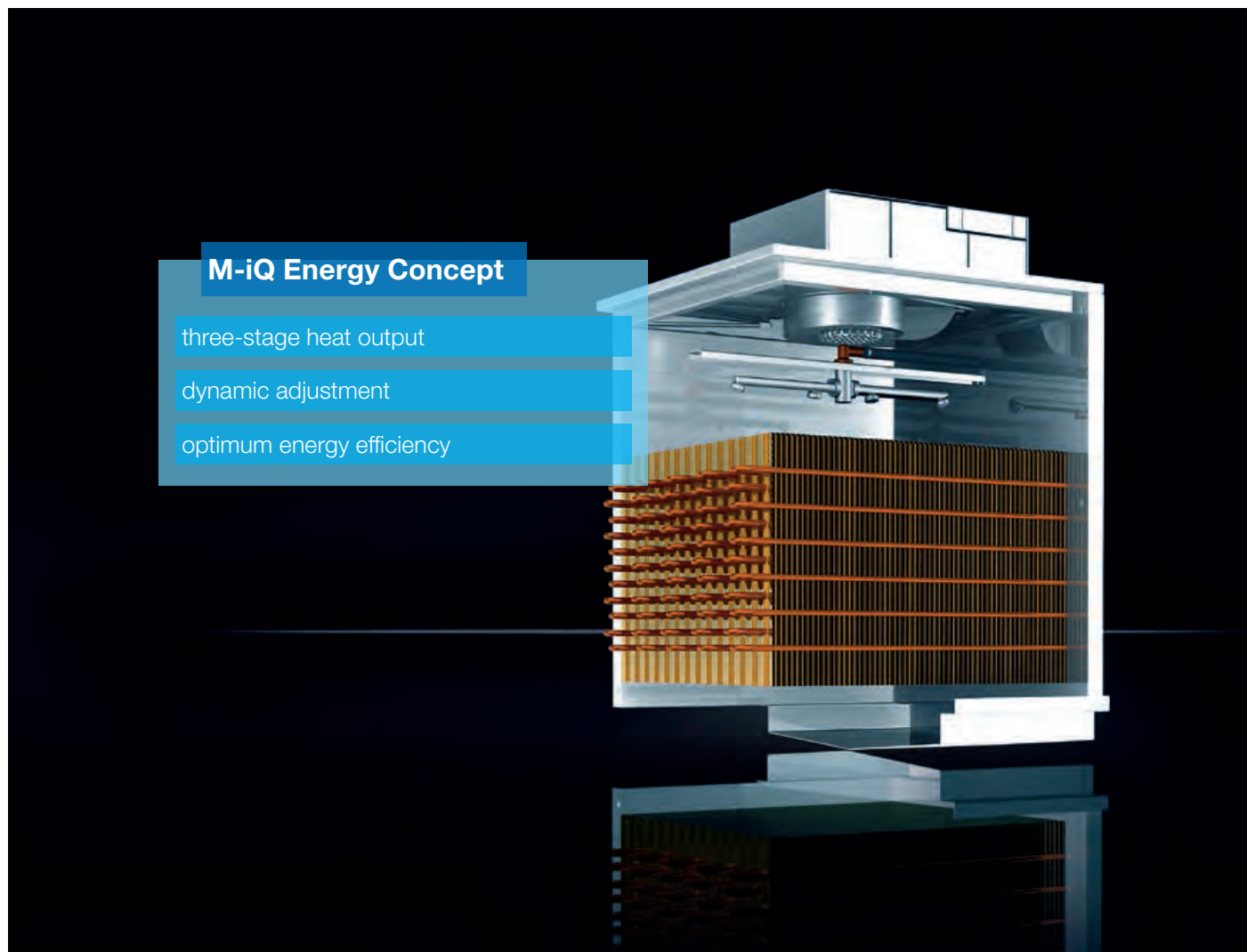

Three positive effects in one perfect concept: Heat recovery reduces energy consumption, exhaust air output and exhaust air temperatures to optimum levels.

M-iQ Self-Cleaning

Spotlessly clean, almost on it's own



Even at the end of a long day of cleaning, the M-iQ still thinks actively. With the tank water available the M-iQ simply cleans itself. Any food soil is discharged through the *M-iQ Filter* with just one filling of the pumped final rinse. This continues in cycles until the machine is empty.

Now only the few areas that are clearly blue need to be cleaned manually. But after the previous automatic cleaning this is easier and can be done more thoroughly, quickly and reliably than ever before. In other words: no problem – it's taken care of.



The intelligent self-cleaning programme of the M-iQ requires little work, providing for increased economic efficiency.

Step by step the tank water cleans the M-iQ, an intelligent cascade system.



M-iQ Washing Dynamics

30 % more cleaning power

MEIKO's well-known high cleaning capacity has been significantly increased and optimised in the M-iQ. Its washing dynamics achieve levels which have not previ-

ously been possible. Maximum cleaning power with a third less consumables and energy consumption. A clean achievement.



M-iQ Washing Dynamics

high pressure washing –
reduced consumables consumption

new computer-designed wash nozzles for
optimal spray pattern geometry

30 % improved cleaning power

The power centre:
the self-emptying
stainless steel wash pump.

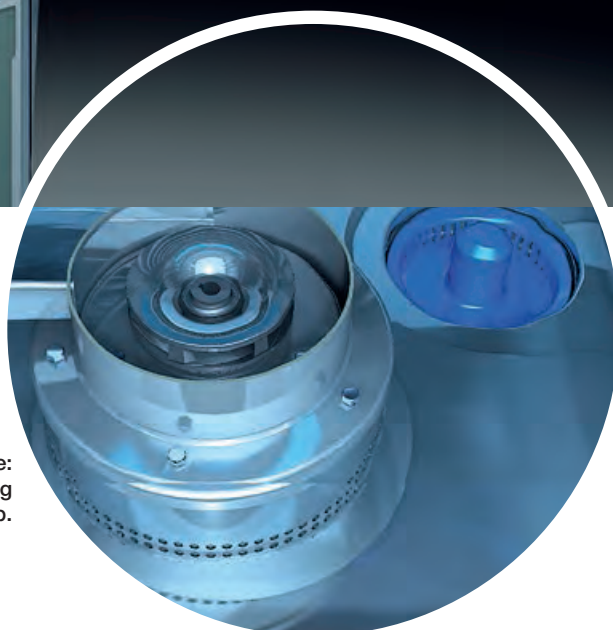

M-iQ Tank Management

A new level of hygiene

Uniquely, the new type of *M-iQ Filter* works in every tank – together they make the perfect team. The show-stopper: The system works against the working direction – the clean area stays truly clean and the residual particles collect far away from the hygienically clean washware.

We do not even leave the water level of the tank to chance. Using the *M-iQ Filter* we transfer water into the adjacent tank or into any tank that needs it, depending on its operational status.

M-iQ Tank Management

intelligent water level control

efficient use of resources

economical in operation

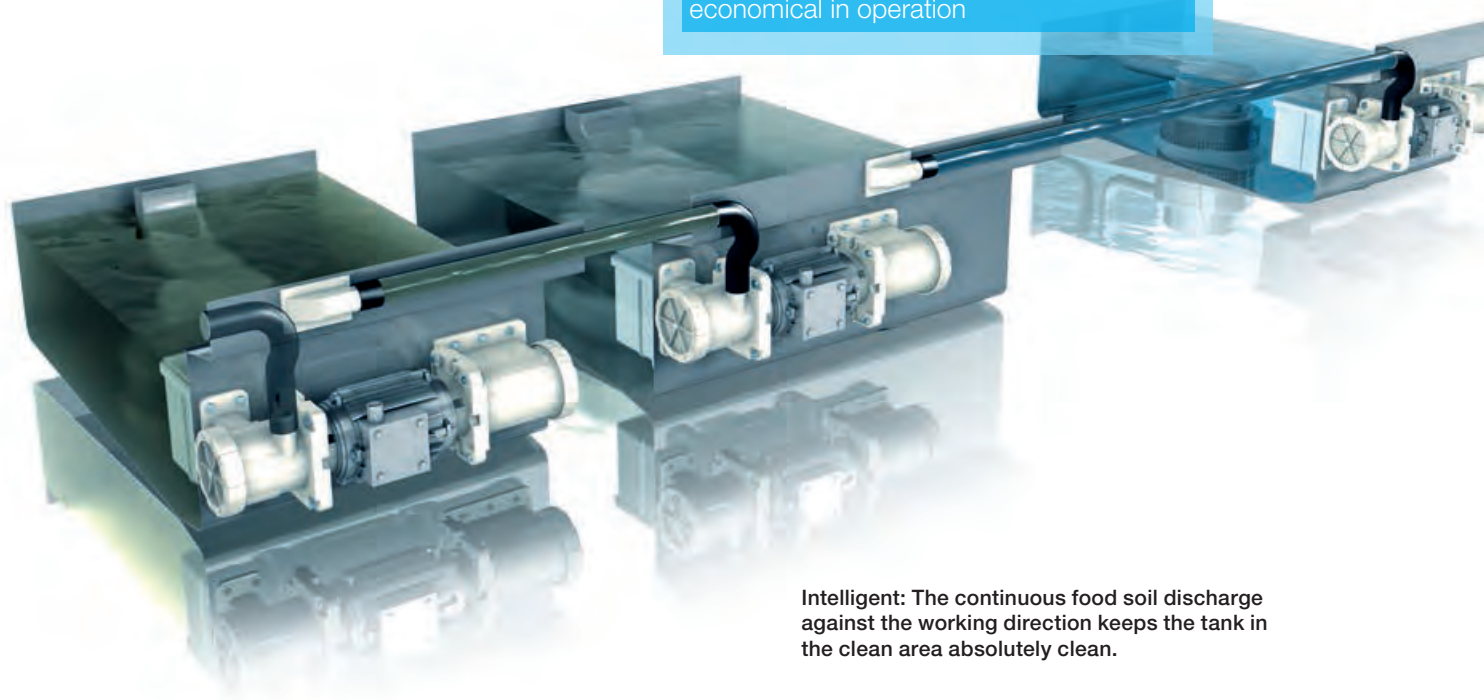

Intelligent: The continuous food soil discharge against the working direction keeps the tank in the clean area absolutely clean.

M-iQ AirConcept

Not just hot air

M-iQ machines use a brand new kind of airflow technology known as MEIKO *AirConcept* which offers maximum hygiene, full adherence to DIN standards and outstanding energy efficiency. The air is conducted from the hot, clean area of the machine to the cool feed area. This prevents contamination and simultaneously harnesses valuable heat for the dishwashing process.

The integrated heat recovery module eliminates the need for a direct exhaust air connection by reducing the quantities of exhaust air to a minimum and making the exhaust air temperatures cooler. As well as the hygiene and environmental benefits, this technology also helps the machine operators by eliminating hot air from the unloading station to create a much more comfortable working environment.

M-iQ AirConcept

maximum energy efficiency

full compliance with DIN standards

no need for exhaust air connection



Keeping things cool: The flow of heat is diverted, the hot steam and vapour cool down – and the M-iQ takes the opportunity to gain new dishwashing energy.

M-iQ AirComfort Drying

All-round perfection with new AirStream technology

The flow of air in the M-iQ drying zone is effectively decoupled from the wash zone thanks to specially designed equalisation openings (*AirComfort drying*) and carefully guided air flow (*AirStream technology*).

This achieves all-round drying excellence while retaining valuable energy at all stages of the process. It also creates the best possible conditions for the people unloading the machine.

M-iQ AirComfort Drying

advantage of separated air flows

superb drying results

outstanding energy efficiency

remarkably user friendly



Unique benefit 1

The drying performance of the M-iQ AirComfort drying process!

The flow of air is effectively decoupled from the wash zone thanks to a series of specially designed equalisation openings. This significantly improves the conditions for people working at the discharge section. The air flows that start here and move through the wash zones form the basis of the innovative M-iQ AirConcept system.

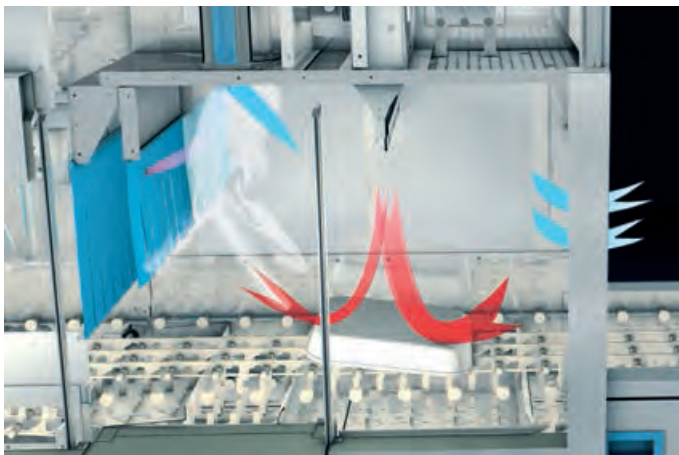

Unique benefit 2

M-iQ achieves great drying results even when washing containers! Even if the air flow is disrupted, the special openings maintain optimum drying conditions by letting in additional air. This also promotes stable air flow through the wash zones, ensuring top-notch energy efficiency and consistently low running costs.

New!

AirStream technology offers even better energy efficiency and perfect drying results



M-iQ AirStream Technology

perfect drying results thanks to flexible and adaptable air nozzle

360 degree all-round drying

improved energy efficiency with 4 guided air streams

the ultimate in user friendliness

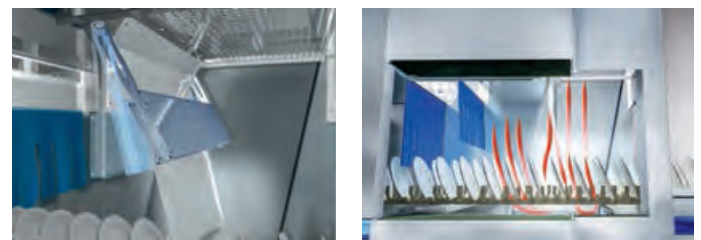

Unique benefit 3:

Drying excellence with new M-iQ AirStream technology

Four air circuits produce a specially guided flow of air that is effectively decoupled from the wash zone. This keeps the energy inside the system and ensures perfect drying results. The flexible air nozzle adjusts to the different heights of the washware, keeping the flow of air at an optimum distance from the ware. The air circulates in a loop that is sealed on all sides, boosting energy efficiency and preventing warm, humid air from escaping at the discharge point. That makes the system even more user-friendly than before.

M-iQ Control Concept

All the information you need – whenever you need it

The *BlueVision* control system software is the brain of the M-iQ. You can control all the dishwashing functions from the *CC-Touch* glass display, safe in the knowledge that it only shows the menu items you can actually use at each point in time. By removing any confusing or unnecessary options from the screen, *CC-Touch* prevents users from operating the machine incorrectly. The user-friendly control system includes a large TFT colour display with a graphical user interface which helps the operator check that everything is running smoothly.

Each user group (kitchen managers, dishwashing personnel, serving staff, etc.) can use the ergonomic M-iQ display to summon up comprehensive information at the touch of a button and save data for subsequent use. Authorised staff members can easily access the control system and systematically define steps to optimise the automated processes. The M-iQ colour display offers a very high resolution which renders graphics, icons and fonts with exceptional brilliance and sharpness.

C Touch



M-iQ System Diagnostics

verified standards of hygiene

enables users to plan start of wash cycle

guaranteed wash results

The integrated system diagnostics function keeps users up-to-date at all times. As soon as the M-iQ is switched on and booted up, it starts a dialogue with the operator, with the dynamic process bar and dedicated status display clearly signalling that all the machine's functions are ready for action. As well as communicating key process data, the display also draws the user's attention to any deviations or discrepancies. Even when it's up and running, the M-iQ is continuously checking all its systems and functions to ensure maximum hygiene and reliability at all times.

C Log

 Easy – reliable – secure. Simply set up a wireless Bluetooth link to your machine's control unit and you can transfer and save all the key system data to a mobile device (*CC-Log* data module) in a matter of seconds – including all the data required to keep an operating log in accordance with DIN SPEC 10534.



The *CC-Log* data module offers a convenient way of transferring operating data via Bluetooth.

M-iQ technology offers the additional option of browsing comprehensive data either online (*CC-Insight*) or on a mobile device (*CC-Log*).

One of our latest features is one-click economy management (optional). Precise readings of your energy and resource consumption (water, detergent, rinse agent) give you detailed insights into the efficiency and cost-effectiveness of your dishwashing process.

The *CC-Insight* software module with economy management allows you to view your consumption patterns in either graphical or tabular form. That gives you the data you need to analyse and optimise your machine's capacity utilisation and individual wash processes.

M-iQ. High-IQ dishwashing – intelligent access to all the data you need.



All system-relevant data, functions and operating processes are stored and displayed by the integrated *KMM communication module*. Operating conditions are analysed and diagnosed, and can be easily changed using the computer as necessary.

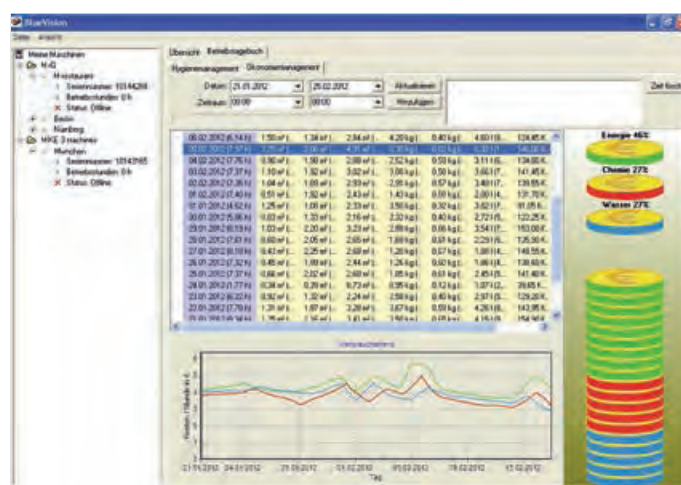
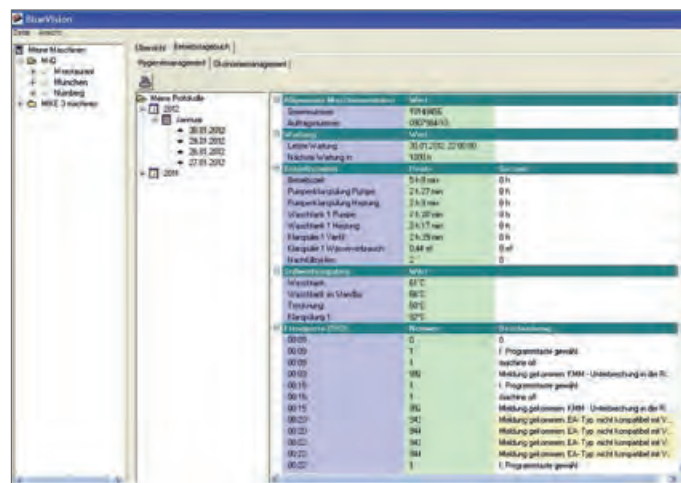

Robust evaluations: *CC-Insight* with economy management

M-iQ GreenEye-Technology®

The green light for a clean future

M-iQ GreenCoach

Always on the right track



The evolution of dishwashing excellence continues: MEIKO has taken the outstanding dishwashing performance of the M-iQ one step further with its revolutionary *GreenEye-Technology*®. This enables genuine teamwork between people and machines for the very first time, leading to concentrated efficiency, greater transparency and a more enjoyable working environment.

The light shows the way: The M-iQ's efficient lighting system helps users make the dishwashing process run more smoothly. It automatically indicates practical steps that can be taken to improve capacity utilization and save resources – similar to the dynamic information provided by a traffic light system. That means that users always know what the M-iQ is doing and exactly how things are going. The M-iQ achieves perfect wash results and all-new levels of cost efficiency by fostering optimum teamwork between people and machines.

- > Teamwork between people and machines
- > Hassle-free dishwashing process
- > Optimized capacity utilization enables significant savings

The intelligent M-iQ *GreenCoach* system works according to the principle of “detect, react, evaluate, recommend, monitor”. This system enables the machine to detect gaps on the conveyor belt between dishware or between baskets. It responds by only activating the rinse function for specific sections of the belt where dishware has been detected – and it can do this while monitoring up to three lines simultaneously. All the gaps on the belts are evaluated with the utmost precision and with a whole new level of detail, enabling savings of up to 50 percent in both fresh water and rinse agent.

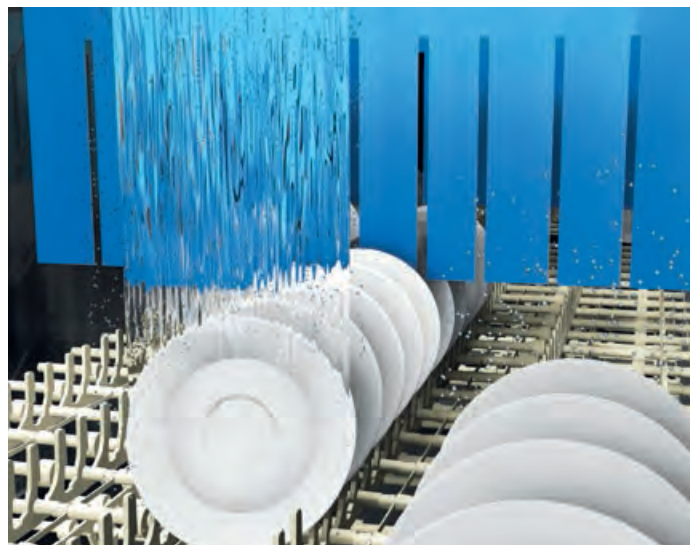

The rinse function is only activated for sections of the belt that actually contain dishware.



M-iQ *GreenCoach* uses a green indicator light to show which lines should be loaded with dishware at the feed point. This enables the M-iQ to run at optimum capacity at all times.



M-iQ GreenCoach

detects gaps in capacity utilization

dynamic adjustment

concrete recommendations for users

M-iQ GreenFilter

A whole new level of cleanliness



We don't see perfection as an unattainable vision, but rather as a day-to-day challenge. That belief has enabled MEIKO engineers to develop a whole new kind of additional filter stage – the *GreenFilter*. This actively removes even the tiniest particles of dirt from the dishwashing machine, achieving unparalleled levels of cleanliness. Thanks to the active *GreenFilter* the machine also uses less fresh water, leading to savings of at least 10 percent. And it only deploys detergent and rinse agent where they are actually needed.

The M-iQ takes a dynamic approach to managing complex tasks: It injects doses of chemicals which are precisely tailored to variations in the speed of the conveyor belt and changing concentrations of dirt on the washware. *GreenEye-Technology*® reduces the cost of detergent and rinse agent to a minimum. And that also applies to energy costs – because the entire dishwashing process only uses what is really necessary at each moment in time.

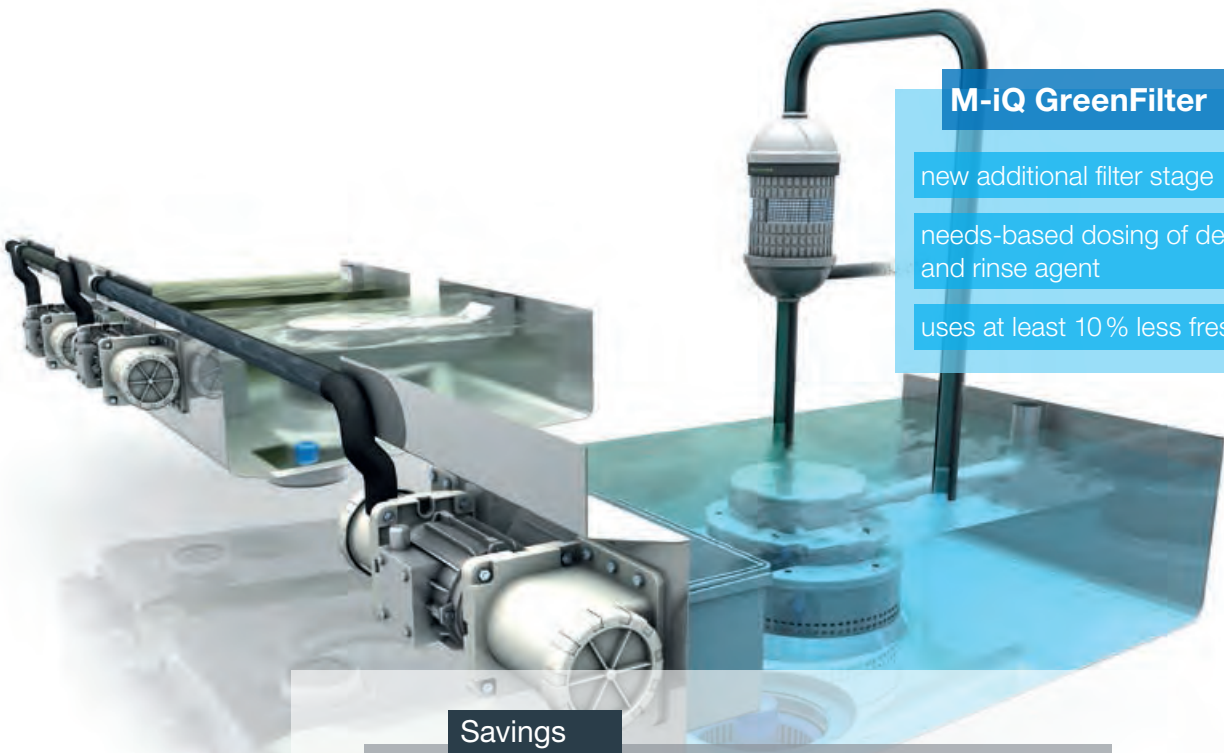

- M-iQ GreenFilter**
- new additional filter stage
- needs-based dosing of detergent and rinse agent
- uses at least 10% less fresh water

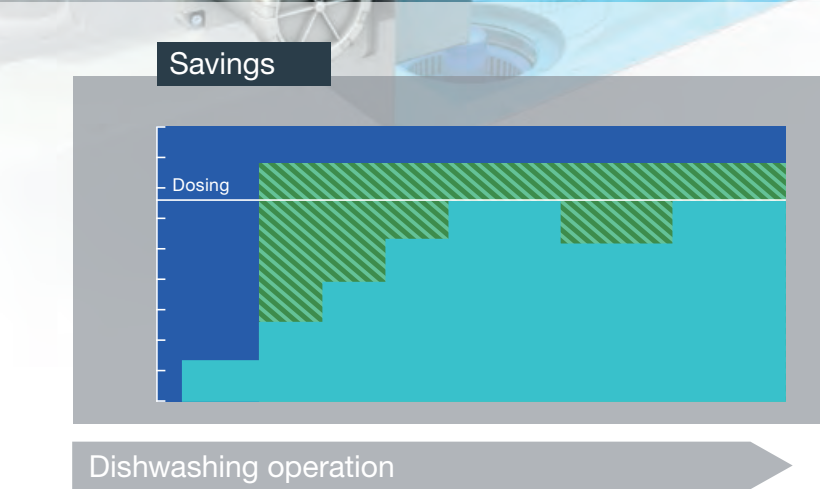

M-iQ Synergies

The big picture

The M-iQ with revolutionary *GreenEye-Technology*[®] creates new synergies between people and machines. It uses a more dynamic and transparent strategy to continuously optimise the dishwashing process. The result is an unparalleled level of efficiency and optimum capacity utilisation. And these synergy effects even extend beyond the machine to encompass the whole kitchen area: The dovetailing of the operators and the M-iQ into an out-

standingly efficient, self-contained unit takes the strain off kitchen managers, allowing them to focus entirely on their leadership duties. Less supervision is required – plus the wash-up area boosts its eco-friendly credentials. *GreenEye-Technology*[®] never loses sight of the big picture and keeps everything under control. That's a green light for a cleaner and more economical future!

M-iQ Synergies

optimum deployment of staff and machines

unparalleled cleanliness and cost-efficiency

takes the strain off kitchen managers



M-iQ Platform Concept

Fits like a glove – always

MEIKO has extensive experience in the construction of flight type machines. The M-iQ is yet another example of MEIKO's series of successes. The M-iQ flight type machine cleans dishes, cups and trays quickly and hygienically. User-friendliness and high performance make the M-iQ a favourite amongst employees and employers alike. The M-iQ sensibly combines ecology and economy. Everyone benefits, operators and the environment.



Universal ability: Uncomplicated handling and well-fitting belt shapes makes the M-iQ an all-purpose machine. Various feeding possibilities and finger widths as well as numerous special belts for hotels, cafeterias and hospitals leave nothing to want.

MEIKO provides the perfect solution for every need. MEIKO rack type machines provide convenience and optimal adaptability to conditions in the wash-up area. The M-iQ rack type machine follows in this tradition. The M-iQ plays an active role whenever there is a wide variety of dishware and cutlery that needs to be cleaned according to diverse schedules. Numerous basket configurations and ergonomic handling make work easier for employees.



The right choice: Technology serves people; MEIKO serves people and the environment. M-iQ sets new standards with its hygienic cleaning methods, economic operation and extremely low consumption levels. Rack on Rack.

Whatever the system designs for the use of the M-iQ might look like, modular M-iQ technology can be used in all situations. The M-iQ fits anywhere.

The available conveyor widths and heights provide for optimal use of space and efficiency. In other words: the M-iQ is at home everywhere.

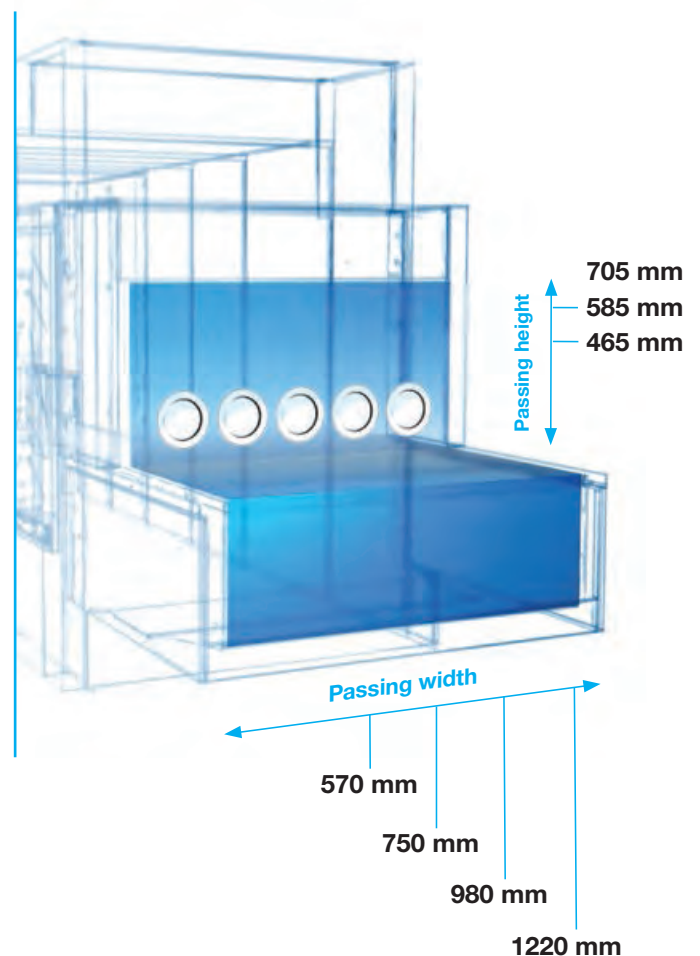

Whether rack type or flight type, the M-iQ fits perfectly with a selection of conveyor dimensions and useful belt widths.

M-iQ GiO-TECH – Integrated reverse osmosis technology for M-iQ rack type and flight type machines

Almost all minerals (as well as bacteria and viruses) are extracted using *GiO-TECH* technology, providing the purest final rinse water.

Not only for glasswashers: De-mineralised water is the

basic requirement for a brilliant and hygienic final rinse of cutlery, dishes and containers. Even during the planning phase *GiO-TECH* shines with its simple and space-saving installation!



1 MEIKO GiO-TECH shines during the planning phase

- Everything from one supplier
- No need to purchase a separate RO unit
- Only one water connection required
- No additional space required
- More cost-conscious planning



2 MEIKO GiO-TECH shines during service

- Monitoring of *GiO-TECH* by the warewasher control unit
- Significant reduction of spare parts stockholding as the unit comes in one size
- Service work on only one machine required
- No operating staff involvement
- Reduction of after-sales costs
- Remote diagnosis possible



During after-sales-service *GiO-TECH* shines with its standardised operation for all warewasher sizes! *GiO-TECH* shines in the eyes of our customers with its short pay back period and brilliant results mean delighted guests! In terms

of environment and hygiene *GiO-TECH* shines by conserving resources while providing a high level of cleanliness! According to our slogan: MEIKO, the clean solution!

Functional principle of MEIKO GiO-TECH

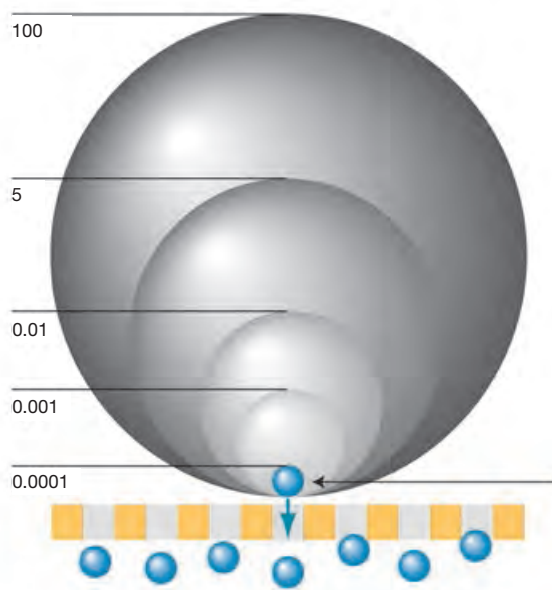

Only pure water molecules can pass through the membrane.



3 MEIKO GiO-TECH shines in the eyes of customers

- Brilliant and hygienically-perfect cleaning results
- Less wear and tear on glasses and crockery
- No hand polishing by staff
- Reduced investment and operating costs
- Excellent cleaning results mean happy guests



4 MEIKO GiO-TECH shines for the environment

- Reduced use of chemicals
- Increased hygiene security



M-iQ Best Sellers

Examples of available M-iQ models and sizes

S and M models based on example of two rack type dishwashing machines
L and XL models based on example of two flight type dishwashing machines
With this much flexibility on offer, you can be sure of getting a basic configuration that perfectly matches your needs!

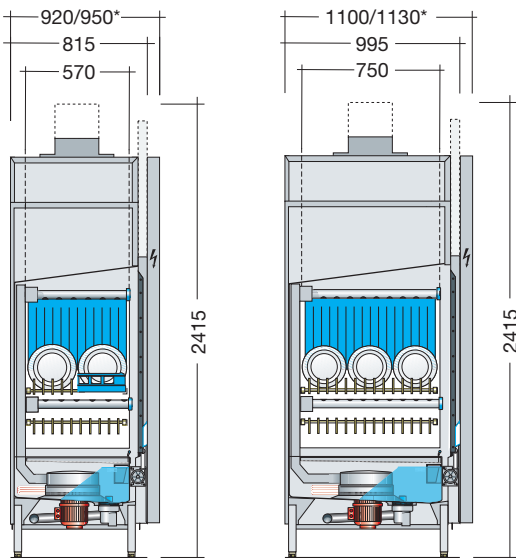
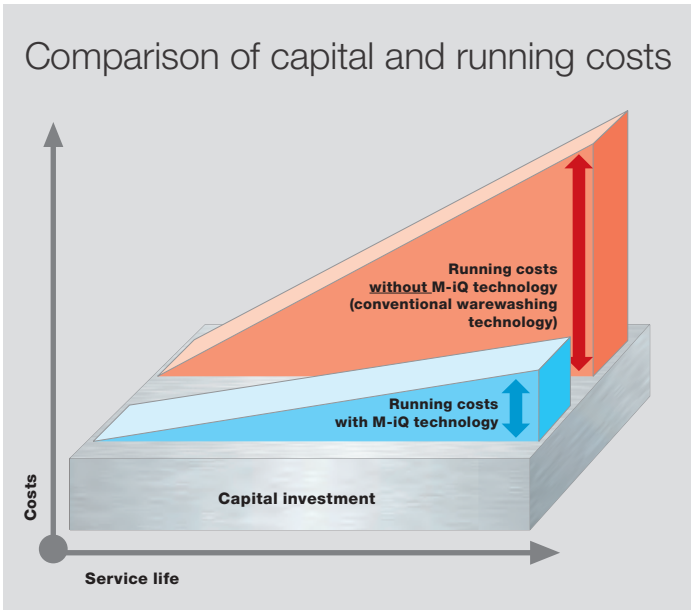

* Depends on machine capacity

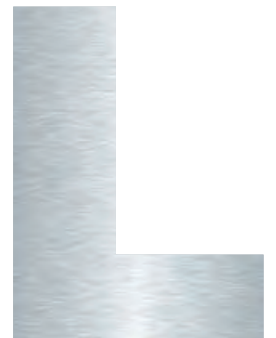

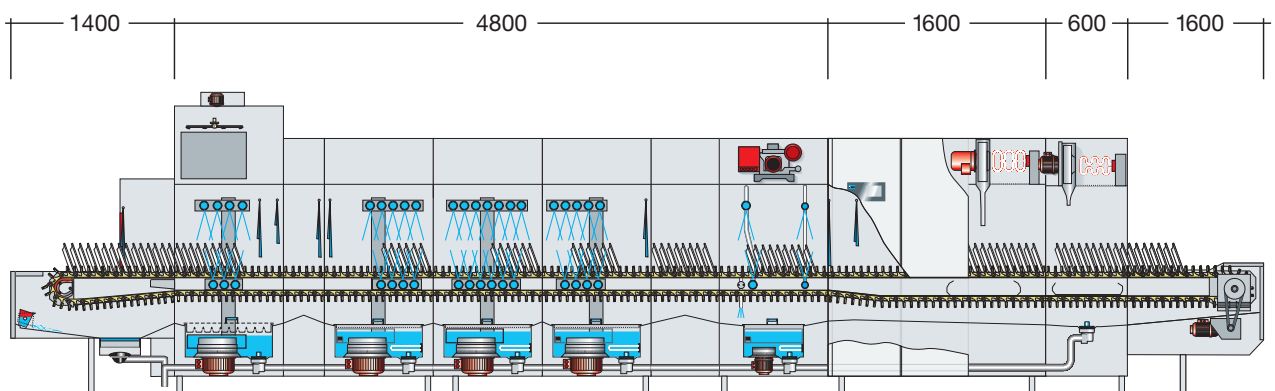
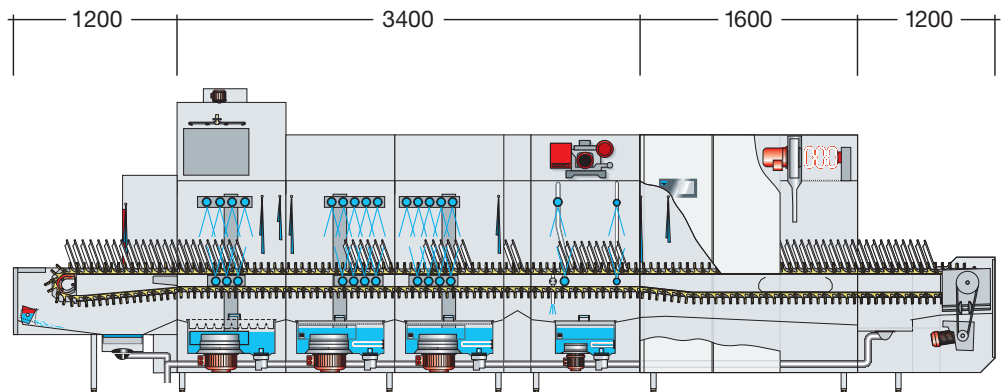
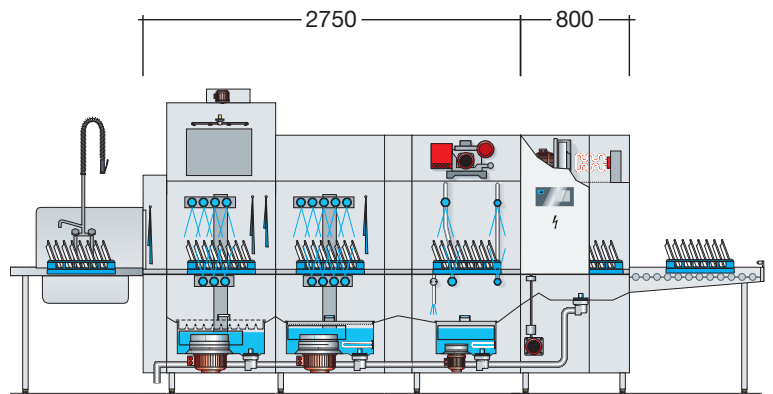
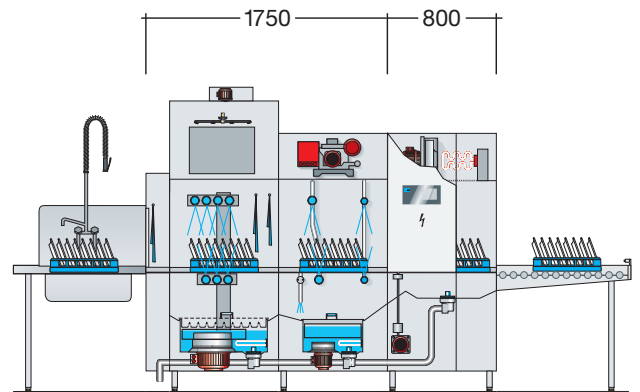

M-iQ Technical Data:

Available formats and sizes

M-iQ flight type machines		Passing width	Plate capacity with 2 minutes contact time as per DIN SPEC 10534	Conveyor speed ⁽¹⁾ for 2 minutes contact time as per DIN SPEC 10534
Passing height: 465 mm				
		mm	plates/h	m/min
B-S54	P6	570	1,730	0.78
B-S74		750	2,600	
B-S54	P8	570	1,950	0.88
B-S74		750	2,930	
B-M54	V6 P6 (best seller)	570	2,400	1.08
B-M74		750	3,600	
B-M54	V8 P6 (best seller)	570	2,620	1.18
B-M74		750	3,930	
B-M54	V6 N02 P6 (best seller)	570	2,600	1.18
B-M74		750	3,930	
B-M54	V8 N02 P8 (best seller)	570	3,060	1.38
B-M74		750	4,600	
B-M54	V8 N33 P8	570	3,500	1.58
B-M74		750	5,260	
B-L54	V8 N02 P8	570	3,950	1.78
B-L74		750	5,930	
B-L54	V8 N24 P8	570	4,400	1.98
B-L74		750	6,600	
B-L54	V8 N66 P8	570	5,060	2.28
B-L74		750	7,600	
B-XL54	V8 N35 P8	570	5,500	2.48
B-XL74		750	8,270	
B-XL54	V8 N66 P8	570	5,950	2.68
B-XL74		750	8,930	

M-iQ rack type machines		Rack capacity with 2 minutes contact time as per DIN SPEC 10534	Conveyor speed ⁽¹⁾ for 2 minutes contact time as per DIN SPEC 10534
Passing height: 465 mm			
Passing width: 570 mm		racks/h	m/min
Rack size: 500 x 500 mm			
K-S54	P6	95	0.78
K-S54	P8	105	0.88
K-S54	N02 P8	115	0.98
K-M54	V6 P6 (best seller)	130	1.08
K-M54	V8 P6 (best seller)	145	1.18
K-M54	V8 P8 (best seller)	155	1.28
K-M54	V8 N02 P8 (best seller)	165	1.38
K-M54	V8 N22 P8	175	1.48
K-M54	V8 N33 P8	190	1.58
K-M54	V8 N44 P8	205	1.68
K-L54	V8 N02 P8	215	1.78
K-L54	V8 N22 P8	225	1.88

⁽¹⁾ The additional two conveyor speeds can be individually tailored on site to match the level of soiling, drying time, wash ware type, etc. (within a range of DIN -10% to DIN +35%).

⁽²⁾ This is an average value based on a sample place setting and operating mode.

Data for specific installations should be derived from the calculations of ROI and payback period for each specific project.

Quantity of rinse water			Total connected electrical load (incl. drying)	Power consumption ⁽²⁾ (incl. drying)	Exhaust air flow rate ⁽³⁾	Total machine length (incl. loading, drying and discharge sections)
M-iQ	with GreenEye-Technology®					
at full capacity l/h	at full capacity	with gap optimisation up to	kW	kW	m³/h	mm
165	–	–	33.1	25.0	110	4,700
215	–	–	38.8	33.0		
175	–	–	33.1	25.0	110	4,900
230	–	–	38.8	33.0		
165	- 10 %	- 50 %	33.9	23.5	150	5,300
210	- 10 %	- 50 %	39.6	32.0		
165	- 10 %	- 50 %	35.4	23.5	150	5,500
215	- 10 %	- 50 %	41.1	32.0		
165	- 10 %	- 50 %	33.9	23.5	150	5,500
215	- 10 %	- 50 %	39.6	32.0		
165	- 10 %	- 50 %	35.4	24.7	150	5,900
215	- 10 %	- 50 %	41.1	32.0		
165	- 10 %	- 50 %	35.4	26.3	150	6,700
215	- 10 %	- 50 %	41.9	32.0		
175	- 10 %	- 50 %	41.1	27.9	170	7,400
230	- 10 %	- 50 %	46.6	32.0		
180	- 10 %	- 50 %	41.2	29.5	170	7,800
240	- 10 %	- 50 %	46.6	33.7		
195	- 10 %	- 50 %	44.7	34.2	170	8,900
260	- 10 %	- 50 %	50.1	39.1		
200	- 10 %	- 50 %	53.5	33.4	190	9,800
260	- 10 %	- 50 %	62.4	38.8		
205	- 10 %	- 50 %	53.5	35.0	190	10,200
270	- 10 %	- 50 %	62.5	43.1		

Quantity of rinse water		Total connected electrical load (incl. drying)	Power consumption ⁽²⁾ (incl. drying)	Exhaust air flow rate ⁽³⁾	Machine length incl. entry tunnel (excl. drying zone/ exit tunnel and control cabinet)	Machine length excl. drying zone (incl. entry and exit tunnels and control cabinet)
M-iQ	with GreenEye-Technology®					
at full capacity l/h	at full capacity	kW	kW	m³/h	mm	mm
165	–	33.0	25.0	110	1,550	2,050
175	–	33.0	25.0	110	1,750	2,250
175	–	33.0	25.0	110	1,950	2,450
165	- 10 %	33.7	23.5	150	2,150	2,650
165	- 10 %	35.3	23.5	150	2,350	2,850
165	- 10 %	35.3	23.9	150	2,550	3,050
165	- 10 %	35.3	24.7	150	2,750	3,250
165	- 10 %	35.3	25.5	150	2,950	3,450
165	- 10 %	35.3	26.3	150	3,150	3,650
170	- 10 %	35.3	27.1	150	3,350	3,850
175	- 10 %	41.0	27.9	170	3,550	4,050
180	- 10 %	41.0	28.7	170	3,750	4,250

⁽³⁾ The exhaust air temperature depends on the fresh water supply temperature. A cold water feed temperature of max. 12 °C will produce exhaust air conditions of approx. 20 °C (or approx. 22 °C in S model) at 90 percent relative humidity. A direct exhaust air connection is no longer needed to meet the requirements of VDI 2052.

M-iQ Modules/Component Parts

Available formats and sizes

Feed sections/
entry tables

S

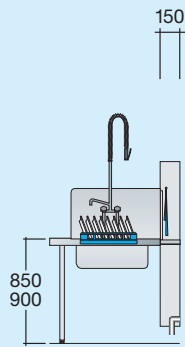

M

L

1000
1200
1400

XL

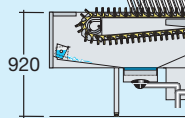

M-iQ B and M-iQ K
pre-wash and main wash zones
(taken from best-selling models
based on example of M-iQ B)

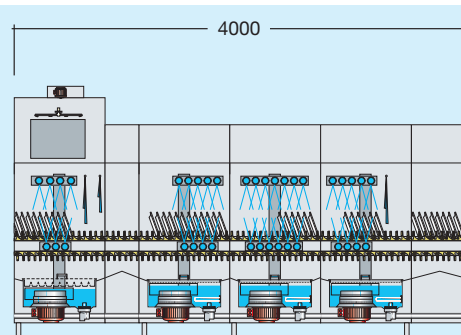
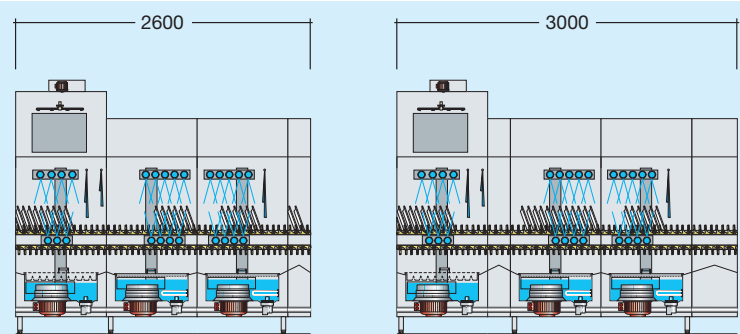
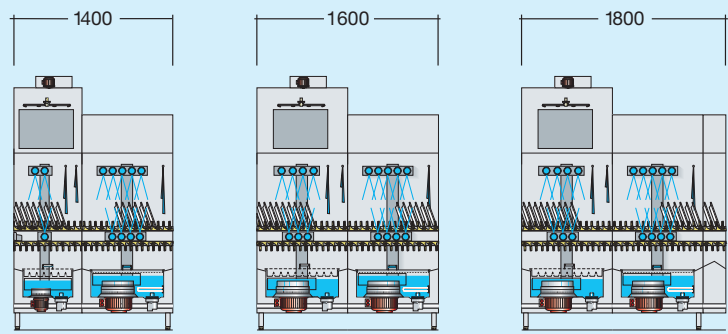
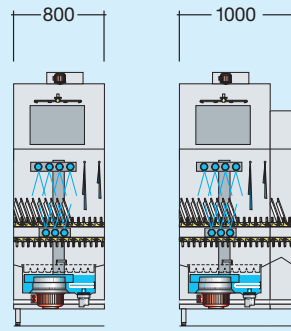

Final rinse zones

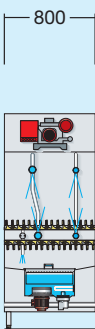
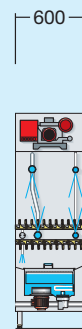
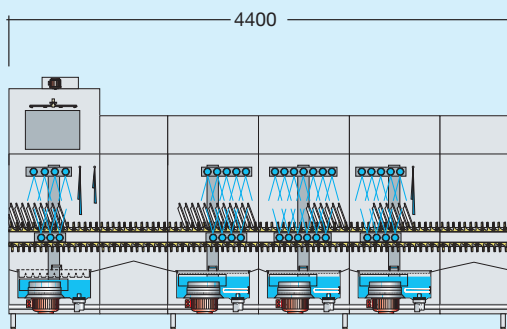
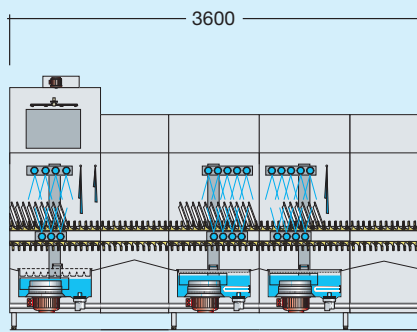
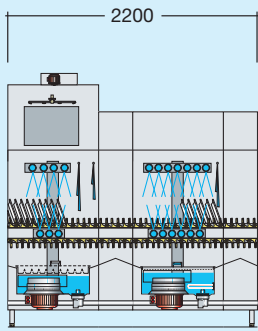

Drying zones/ exit tunnel with control cabinet

500 M-iQ K
800 M-iQ K
1445 M-iQ K
90° bend
180° bend

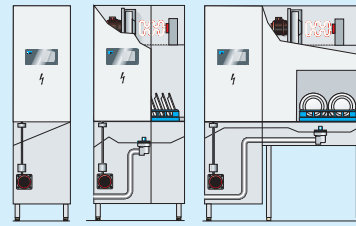

1100
1300
1600

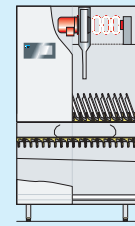

1300
1600
M-iQ B

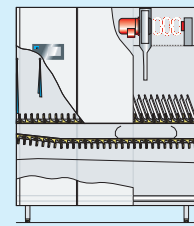

1300 600
1600

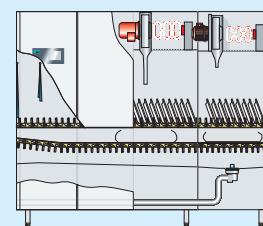

Discharge sections / exit tables

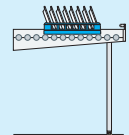

- straight
- 90° curve with drive
- 180° curve with drive

800
1000
1200
1400
1600

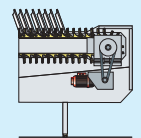



The clean solution



In accordance with the hygiene requirements of DIN SPEC 10534.



MEIKO Maschinenbau GmbH & Co. KG

Englerstr. 3 · 77652 Offenburg · Germany
Phone +49 (0)781 203-0 · Fax +49 (0)781 203-1121
www.meiko.info · info@meiko.de