



UPster K

The quickest route to cleaner washware!

Rack type dishwashing machines for a new generation



EUROPE

UPster K

The quickest route to the MEIKO world of clean solutions



**There's no time to waste –
so let's get started!**

The *UPster* range is the quickest and easiest way to access the MEIKO world of professional warewashing technology. *UPster* offers clean technology at very competitive prices. And we get it to you fast – in most cases delivery takes just one week! That gives both newcomers and savvy professionals the fastest route to a sparkling future.

UPster K range: as flexible as our new generation of customers

Today's world is more flexible and dynamic than ever, and that's why our *UPster K* rack type dishwashing machines are such a great choice. Offering efficient cleaning performance, user-friendly operation, maximum flexibility, and exceptional value for money, *UPster K* machines are the perfect partner for wash-up areas which need basket solutions. And with super fast delivery you can just connect it up and you're ready to go!



UPster K-S 160

Packs plenty of power for up to 120 baskets/h

Sometimes it's fine to start off small – and even with its compact dimensions the *UPster K-S 160* still packs plenty of power to get the job done!



Sectional view of the *UPster K-S 160*

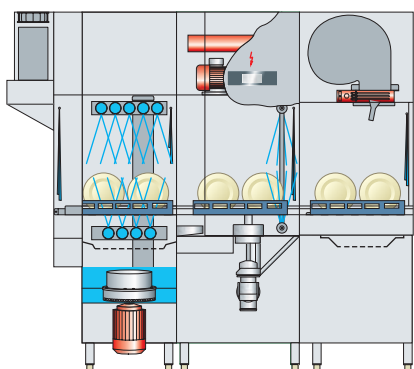

Entry height

508 mm

Basket capacity

80 - 100* - 120 baskets/h

Quantity of rinse water

260 litres/h

Connected load

30.9 kW incl. heat recovery and drying

Power consumption**

21.3 kW incl. heat recovery and drying

Machine length

1,300 mm excl. drying / 1,900 mm incl. drying

* Complies with contact time specified in DIN SPEC 10534. The first basket capacity figure for the K-S 160 is based on a contact time of 2 minutes.

** This is an average value based on an example of a typical place setting and operating mode. Data for specific installations should be derived from the calculations of ROI and payback period for each specific project.

Electrical power supply to the machine 3 NPE, 400V, 50Hz. Main power switch must be provided by customer on site.

UPster K-S 200

Flexes its muscles for up to 150 baskets/h

The *UPster K-S 200* shows its strengths with an additional rinse zone and a major boost in basket capacity.



Sectional view of the *UPster K-S 200*

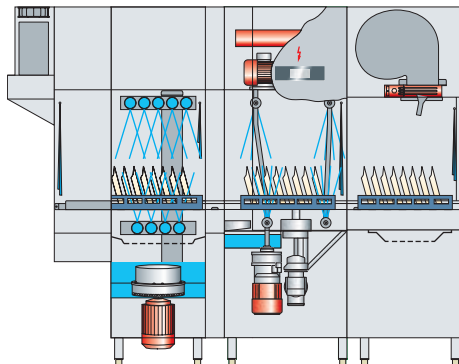

Entry height

508 mm

Basket capacity

95* - 125 - 150 baskets/h

Quantity of rinse water

260 litres/h

Connected load

31.4 kW incl. heat recovery and drying

Power consumption**

21.7 kW incl. heat recovery and drying

Machine length

1,550 mm excl. drying / 2,150 mm incl. drying

* Complies with contact time specified in DIN SPEC 10534.

** This is an average value based on an example of a typical place setting and operating mode. Data for specific installations should be derived from the calculations of ROI and payback period for each specific project. Electrical power supply to the machine 3 NPE, 400V, 50Hz. Main power switch must be provided by customer on site.

UPster K-M 250

Gets the water flowing for up to 190 baskets/h

What's the secret to faster, cleaner results? The additional pre-wash zone in the *UPster K-M 250* makes it easy to wash up to 190 baskets an hour. The speedy solution for outstanding results!



Sectional view of the *UPster K-M 250*

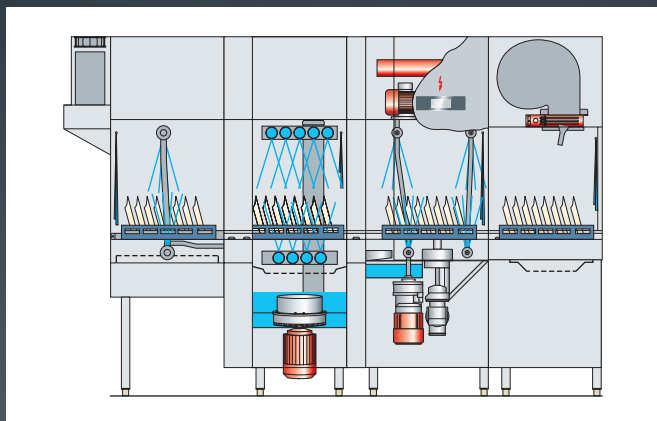

Entry height

508 mm

Basket capacity

125* - 150 - 190 baskets/h

Quantity of rinse water

260 litres/h

Connected load

31.4 kW incl. heat recovery and drying

Power consumption**

21.7 kW incl. heat recovery and drying

Machine length

2,050 mm excl. drying / 2,650 mm incl. drying

* Complies with contact time specified in DIN SPEC 10534.

** This is an average value based on an example of a typical place setting and operating mode. Data for specific installations should be derived from the calculations of ROI and payback period for each specific project.

Electrical power supply to the machine 3 NPE, 400V, 50Hz. Main power switch must be provided by customer on site.

UPster K-M 280

Doubles up the power for up to 210 baskets/h

With its additional wash tank, the *UPster K-M 280* boosts basket capacity even more, allowing you to handle up to 210 baskets an hour. Makes the best use of space to offer outstanding performance.



Sectional view of the *UPster K-M 280*

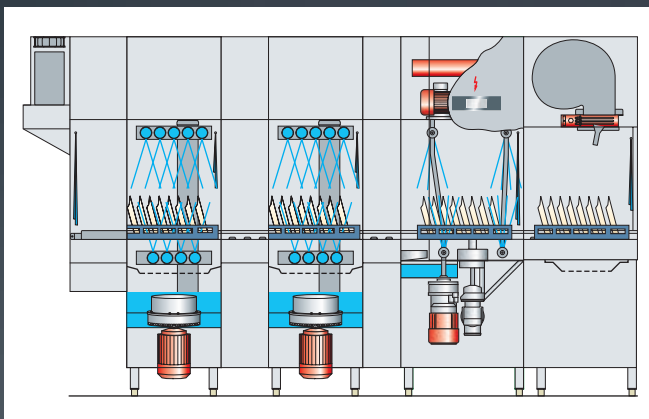

Entry height

508 mm

Basket capacity

140* - 180 - 210 baskets/h

Quantity of rinse water

260 litres/h

Connected load

33.1 kW incl. heat recovery and drying

Power consumption**

22.8 kW incl. heat recovery and drying

Machine length

2,350 mm excl. drying / 2,950 mm incl. drying

* Complies with contact time specified in DIN SPEC 10534.

** This is an average value based on an example of a typical place setting and operating mode. Data for specific installations should be derived from the calculations of ROI and payback period for each specific project.

Electrical power supply to the machine 3 NPE, 400V, 50Hz. Main power switch must be provided by customer on site.

UPster K-L 340

Twice the cleaning capabilities for up to 250 baskets/h

The *UPster K-L 340* doubles up on everything. As well as an additional pre-wash zone, it also features a complete second wash system for maximum power and cleanliness, boosting basket capacity as high as 250 baskets an hour. This machine takes cleaning to the max!



Sectional view of the *UPster K-L 340*

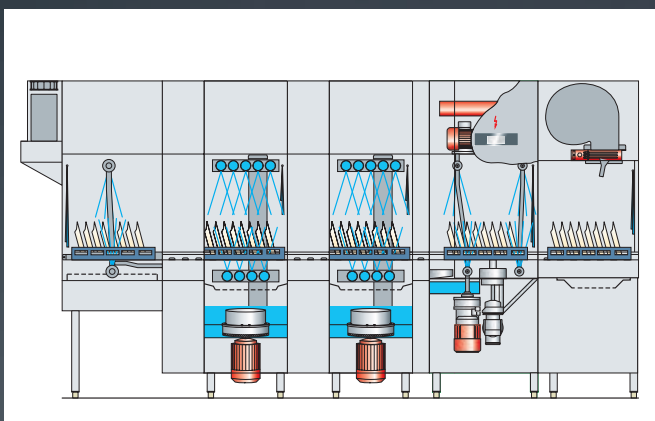

Entry height

508 mm

Basket capacity

170* - 210 - 250 baskets/h

Quantity of rinse water

260 litres/h

Connected load

39.6 kW incl. heat recovery and drying

Power consumption**

27.3 kW incl. heat recovery and drying

Machine length

2,850 mm excl. drying / 3,450 mm incl. drying

* Complies with contact time specified in DIN SPEC 10534.

** This is an average value based on an example of a typical place setting and operating mode. Data for specific installations should be derived from the calculations of ROI and payback period for each specific project.

Electrical power supply to the machine 3 NPE, 400V, 50Hz. Main power switch must be provided by customer on site.

Thanks to their modular design, *UPster K* machines can be nice and compact or big and bold. But whatever size they are, they always make the best use of the available space. *UPster K*.

Fits beautifully into your kitchen layout, but still costs less than a made-to-measure machine.

UPster K-S 160

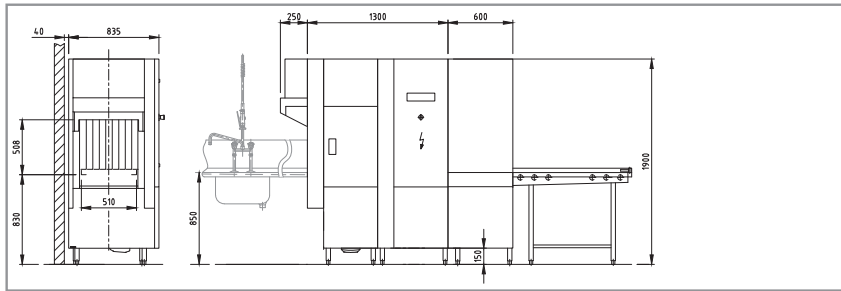

UPster K-S 200

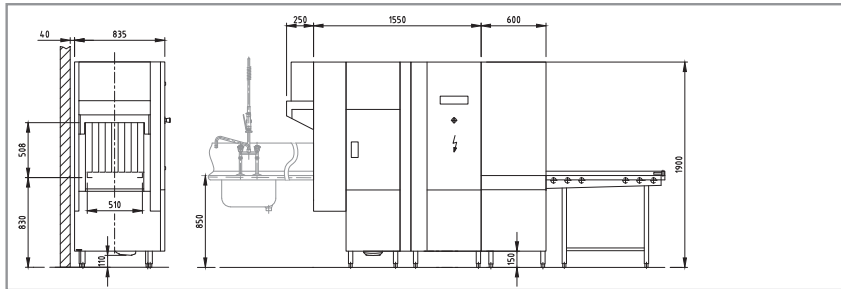

UPster K-M 250

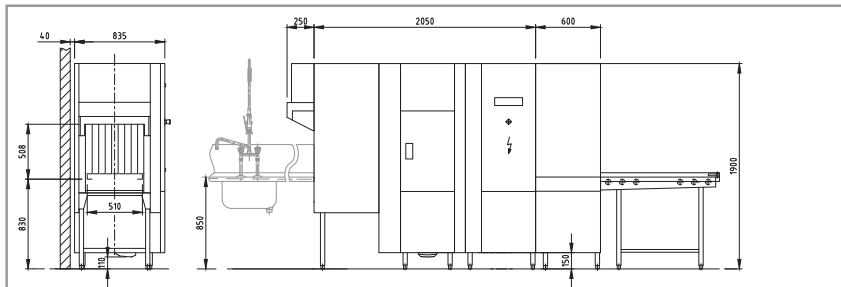

UPster K-M 280

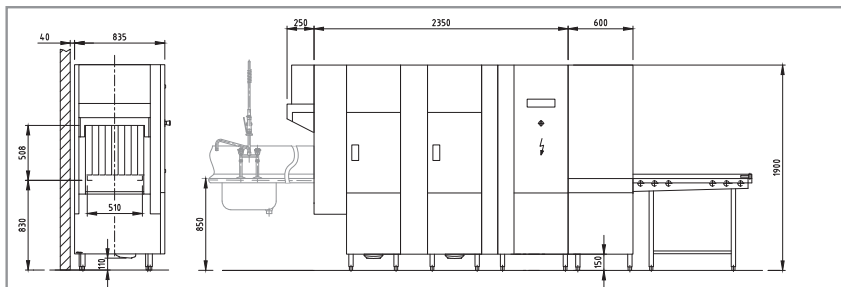

UPster K-L 340

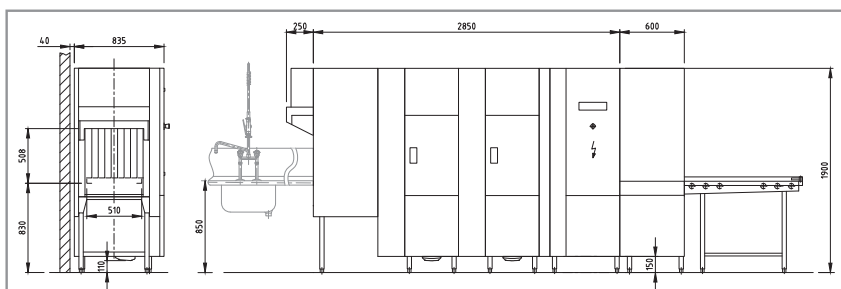

UPster K

Full power and full control with just one touch



UPster K offers sophisticated technology in a user-friendly MEIKO package, setting new standards in speed, cleanliness and reliability.

Highlights include easy-clean technology, user-friendly operation thanks to blue-tagged components, an energy-saving machine design which eliminates the need for an air extraction system, and ergonomic operation using an innovative glass display panel.

Clarity is the number one priority. The high-contrast illuminated glass display panel keeps the operator fully informed at every stage of the wash process. It only displays the functions which are currently available for use or currently in progress, effectively eliminating the risk of operator errors. All the key information is available at a glance, and a constant dialogue is maintained between the machine and its human operators.



One-touch operation makes it easy for the operator to navigate through the programme options.

UPster K

Optimum indoor air quality without requiring an exhaust air vent



Work in a kitchen often gets heated – but MEIKO technology helps keep things cool. *UPster K* machines work with a built-in heat recovery system. As well as cutting back on the use of water and energy, that also maximises efficiency. What's more, it keeps the indoor air quality at a pleasant level which staff will be sure to appreciate.

UPster K machines do not require any additional exhaust vent, so that saves you the cost of fitting a standard separate exhaust air connection.* Overall this range of machines provides a user-friendly package which minimises the environmental impact of warewashing while offering a convincing ROI and payback period. *UPster K* is the perfect choice for shrewd spenders.



* Assuming adequate ventilation in line with VDI 2052 regulations (Association of German Engineers).

UPster K

508 mm – plenty of room to spare!

Big pots and pans and long trays can be the toughest kind of washware to tackle. But the MEIKO *UPster K* takes everything in its stride. With a maximum passing height

of 508 mm, *UPster* machines set a new standard in their class. They can comfortably accommodate bulky items and get them sparkling clean. Sounds like the perfect solution!

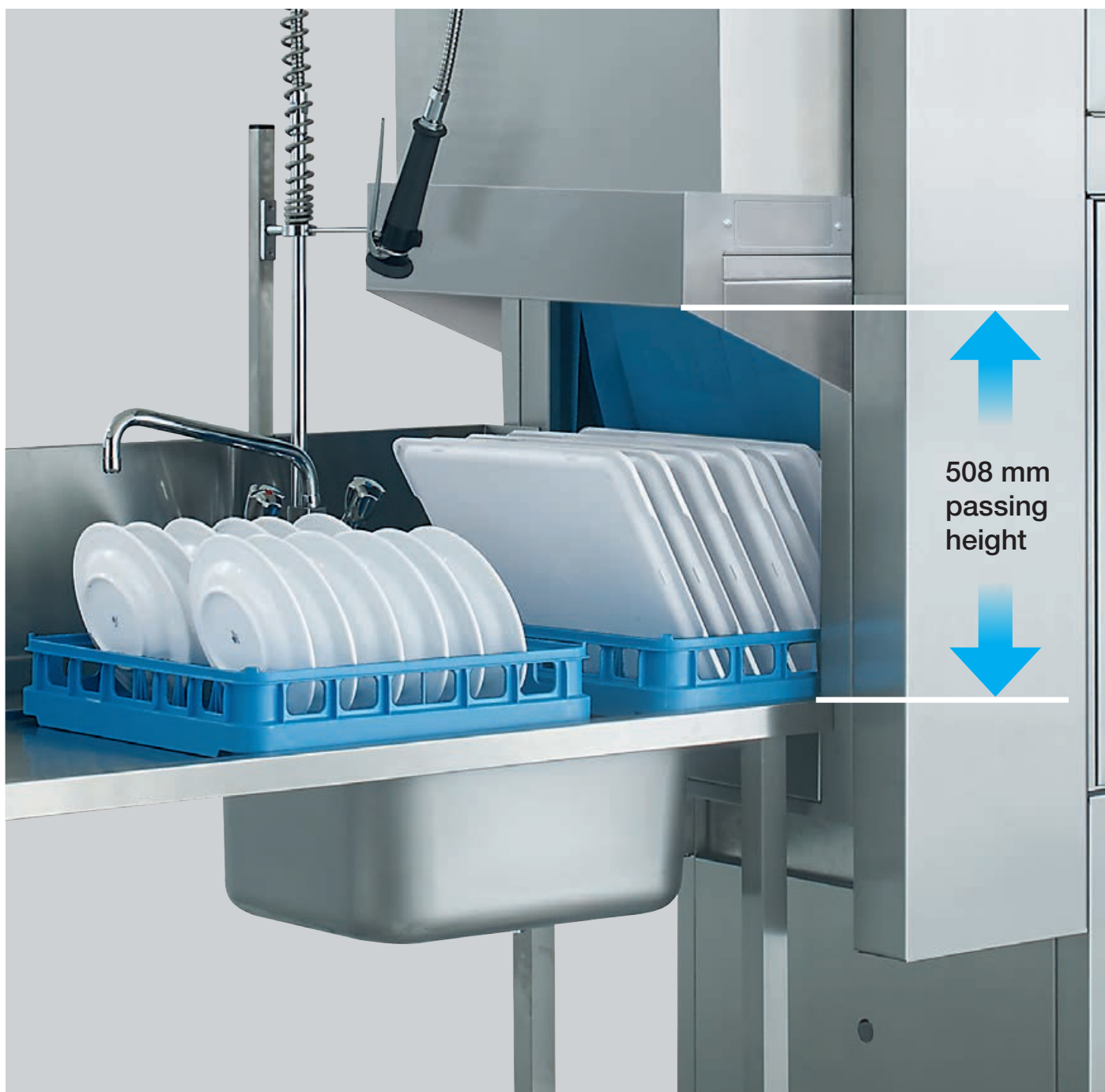

UPster K

Blue is the colour of user-friendly operation

MEIKO uses a striking blue to mark all the components and parts of its machines which users can interact with. This intuitive solution makes life easier for users without requiring words or long instruction manuals.

This is MEIKO's way of making communication between machines and humans as easy and efficient as possible. It's teamwork at its best – and the most enjoyable way of achieving professional results.



Combine different modules to get the best out of MEIKO technology. From simple dishwashing systems with straight sliding tables to motorised 90° or 180° roller conveyors and sophisticated rinsing units, *UPster K* can be whatever you

want it to be. We would be glad to discuss your needs in more detail to decide which option best meets your requirements in regard to cost, efficiency and ergonomics.

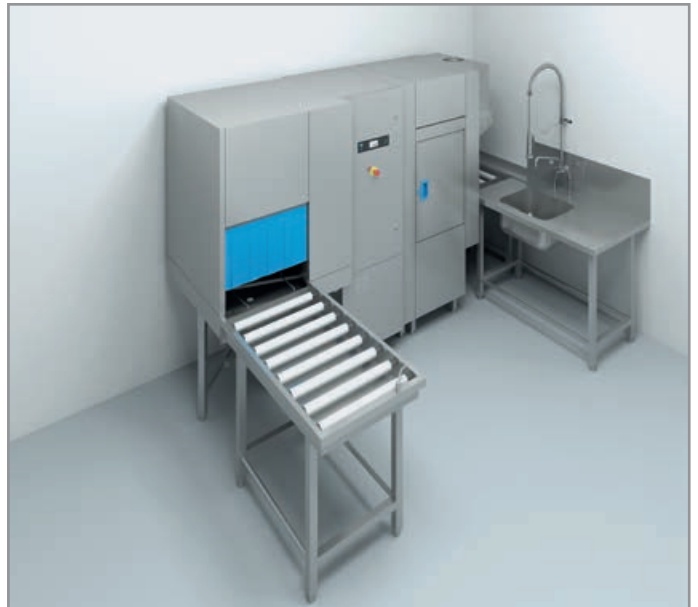
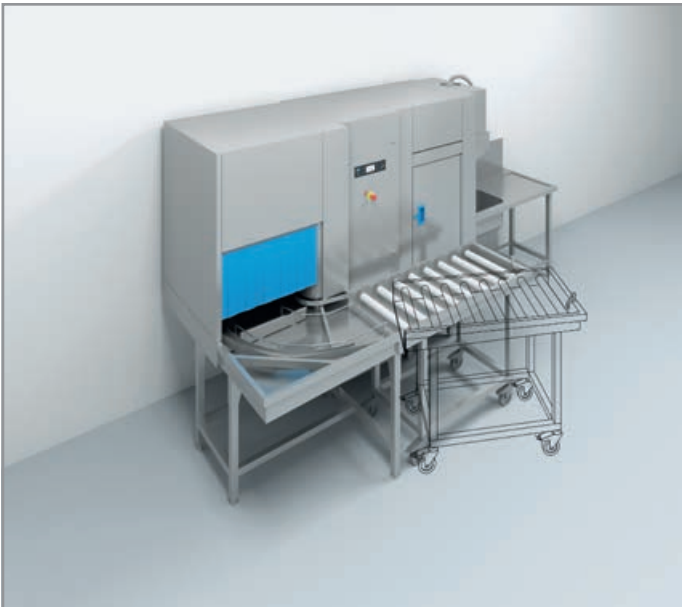
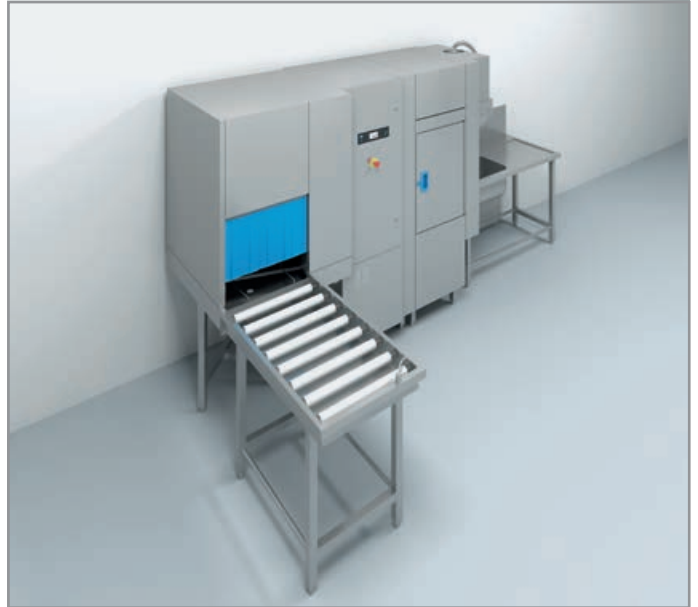
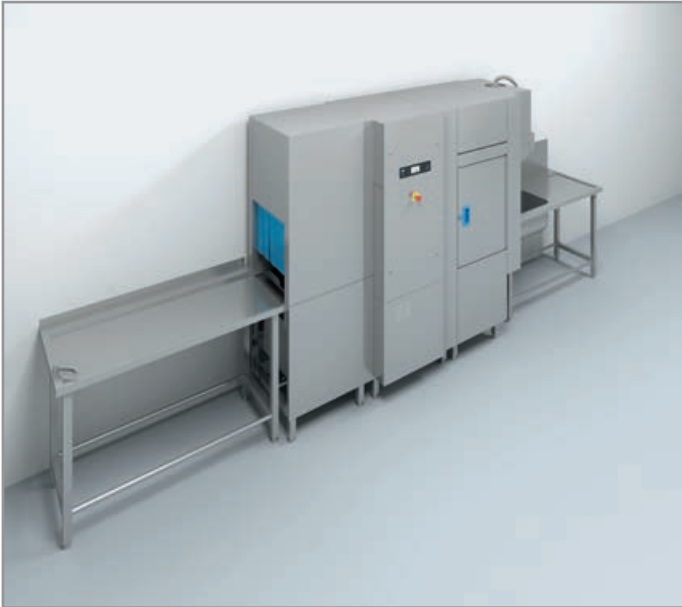

Meets the hygiene requirements of DIN SPEC 10534.

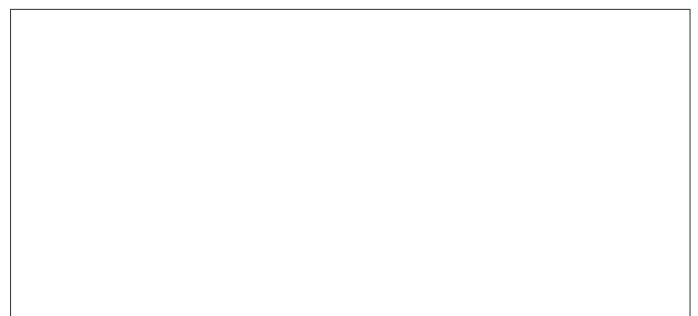

121.070.00.09.16/EUROPE/KD/XXXX

We reserve the right to amend specifications as part of our product improvement process.